

A data mining approach to compressive strength of CFRP-confined concrete cylinders

S.M. Mousavi^{1a}, A.H. Alavi^{*2}, A.H. Gandomi^{3b}, M. Arab Esmaeili⁴ and M. Gandomi²

¹Department of Civil Engineering, Sharif University of Technology, Tehran, Iran

²School of Civil Engineering, Iran University of Science and Technology, Tehran, Iran

³College of Civil Engineering, Tafresh University, Tafresh, Iran

⁴Department of Civil Engineering, Islamic Azad University, Shahrood Branch, Shahrood, Iran

(Received May 11, 2010, Accepted October 6, 2010)

Abstract. In this paper, compressive strength of carbon fiber reinforced polymer (CFRP) confined concrete cylinders is formulated using a hybrid method coupling genetic programming (GP) and simulated annealing (SA), called GP/SA, and a robust variant of GP, namely multi expression programming (MEP). Straightforward GP/SA and MEP-based prediction equations are derived for the compressive strength of CFRP-wrapped concrete cylinders. The models are constructed using two sets of predictor variables. The first set comprises diameter of concrete cylinder, unconfined concrete strength, tensile strength of CFRP laminate, and total thickness of CFRP layer. The most widely used parameters of unconfined concrete strength and ultimate confinement pressure are included in the second set. The models are developed based on the experimental results obtained from the literature. To verify the applicability of the proposed models, they are employed to estimate the compressive strength of parts of test results that were not included in the modeling process. A sensitivity analysis is carried out to determine the contributions of the parameters affecting the compressive strength. For more verification, a parametric study is carried out and the trends of the results are confirmed via some previous studies. The GP/SA and MEP models are able to predict the ultimate compressive strength with an acceptable level of accuracy. The proposed models perform superior than several CFRP confinement models found in the literature. The derived models are particularly valuable for pre-design purposes.

Keywords: CFRP-confined concrete; compressive strength; genetic programming; simulated annealing; multi expression programming; formulation.

1. Introduction

Concrete as a frictional material is considerably sensitive to hydrostatic pressure. Lateral stresses have advantageous effects on the concrete strength and deformation. Concrete exhibits increased strength and axial deformation capacity when it is uniaxially loaded and cannot dilate laterally. This case indicated as confinement. The concrete confinement can generally be provided through transverse reinforcement in the form of spirals, circular hoops or rectangular ties, or by encasing the

*Corresponding author, Researcher, E-mail: ah_alavi@hotmail.com

^aE-mail: m_mousavi@engineer.com

^bE-mail: a.h.gandomi@gmail.com

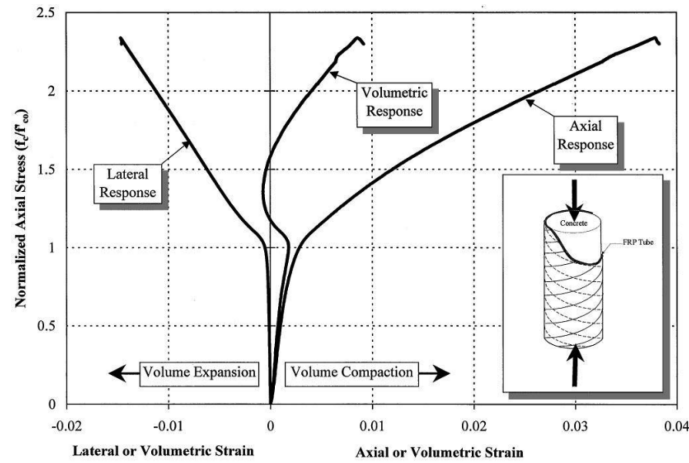


Fig. 1 Typical response of FRP-confined concrete (Mirmiran *et al.* 2000)

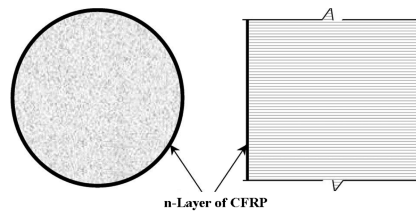


Fig. 2 Illustration of a CFRP confining concrete cylinder

concrete columns into steel tubes that act as permanent formwork (Lorenzis 2001). Fiber reinforced polymers (FRPs) are also used for the confinement of concrete columns. Compared to steel (Fardis and Khalili 1982), FRPs present several advantages such as continuous confining action to the entire cross-section, easiness and speed of application, and corrosive resistance (Lorenzis 2001). A typical response of FRP-confined concrete is shown in Fig. 1. In this figure, normalized axial stress is plotted against axial, lateral, and volumetric strains. The stress is normalized with respect to the unconfined strength of the concrete core. This figure depicts that both the axial and lateral responses are bi-linear with a transition zone at or near the peak strength of the unconfined concrete core. The volumetric response shows a similar transition toward volume expansion. However, as soon as the jacket takes over, the volumetric response undergoes another transition which reverses the dilation trend and results in volume compaction. This behavior of FRP-confined concrete is remarkably different from plain concrete and steel-confined concrete, both of which fail by excessive unstable volume expansion (Mirmiran *et al.* 2000).

Carbon fiber reinforced plastic (CFRP) is one of the main types of the FRP composites. The advantages of CFRP comprise anti-corrosion, easy cutting and construction, as well as high strength-to-weight ratio and high elastic modulus. These features have caused widely using of CFRP in retrofitting and strengthening of reinforced concrete structures for over 50 years. A typical CFRP-confined concrete cylinder is illustrated in Fig. 2.

Several studies have been conducted to analyze the CFRP confinement effect on the strength and deformation capacity of concrete columns. On the basis of these researches, a number of empirical

and theoretical models are developed (Lorenzis 2001). In spite of extensive research in this field, the available models have some significant limitations. Such models have been derived for specific loading systems and conditions. In most cases, several involving parameters should be calibrated before the application of these models. These limitations suggest the necessity of developing more comprehensive mathematical models for assessing the behaviour of CFRP-confined concrete columns.

Genetic programming (GP) (Koza 1992) can be regarded as a new alternative approach for the behavior modeling of concretes. GP is an extension of genetic algorithms. It may generally be defined as a supervised machine learning technique that searches a program space instead of a data space. The main advantage of the GP-based approaches is their ability to generate prediction equations without assuming prior form of the existing relationship. The developed equations can be easily manipulated in practical circumstances. In recent years, many researchers have employed GP and its variants to find out any complex relationships among the experimental data (e.g., Cevik and Sonebi 2008, Canakci *et al.* 2009, Mousavi *et al.* 2010, Gandomi *et al.* 2010a,b). Multi expression programming (MEP) (Oltean and Dumitrescu 2002) is a recent variant of GP that uses a linear representation of chromosomes. MEP has a special ability to encode multiple solutions of a problem in a single chromosome. Based on numerical experiments, the MEP approach is able to outperform similar techniques (Oltean and Grosan 2003a). Some of the limited scientific efforts directed at applying MEP to civil engineering tasks include predicting limestone compressive and tensile strength (Baykasoglu *et al.* 2008), formulation of soil classification (Alavi *et al.* 2010a), and formulation of geotechnical engineering systems (Alavi and Gandomi 2010).

Simulated annealing (SA) is a general stochastic search algorithm used for solving optimization problems. The Metropolis algorithm, the foundation of SA, was proposed by Metropolis *et al.* (1953) to simulate the annealing process. SA was first presented by Metropolis *et al.* (1953) to mimic the natural process of metal annealing. This algorithm was first applied to optimization problems by Kirkpatrick *et al.* (1983) and Cerny (1985). SA is very useful for solving several types of optimization problems with nonlinear functions and multiple local optima. Folino *et al.* (2000) and Deschaine *et al.* (2000) combined GP and SA to make a hybrid algorithm with better efficiency. The SA strategy was used to decide the acceptance of a new individual. It was shown that introducing this strategy into the GP process improves the profitability of GP. Recently, Alavi *et al.* (2010b) utilized this hybrid method to formulate the flow number of asphalt mixes.

The main purpose of this paper is to derive new prediction models for the ultimate compressive strength of CFRP-wrapped concrete cylinders via the GP/SA and MEP techniques. A comprehensive database including previously published test results is utilized to develop the models. The performance of the proposed models is further compared with that of several existing models. The formulas evolved by GP/SA and MEP can reliably be employed for the evaluation of the compressive strength of wrapped concrete cylinders.

2. Review of previous studies

The characteristic response of the confined concrete includes three distinct regions of un-cracked elastic deformations, crack formation and propagation, and plastic deformations. It is generally assumed that concrete behaves like an elastic-perfectly plastic material after reaching its maximum strength capacity. The failure surface is considered to be fixed in the stress space. Constitutive models for concrete should be concerned with pressure sensitivity, path dependence, stiffness

degradation, and cyclic response. The existing plasticity models range from nonlinear elasticity, endochronic plasticity, classical plasticity, and multi-laminate or micro-plane plasticity to bounding surface plasticity. Many of these models, however, are only suitable in a specific application and loading system for which they are devised and may give unrealistic results in other cases. Also, some of these models require several parameters to be calibrated based on the experimental results

Table 1 Different models for strength enhancement of FRP confined concrete cylinders

ID	Authors	Equation
1	Fardis and Khalili (1981)	$\frac{f'_{cc}}{f'_{co}} = 1 + 3.7 \left(\frac{P_u}{f'_{co}} \right)^{0.85}$
2	Mander <i>et al.</i> (1988)	$\frac{f'_{cc}}{f'_{co}} = 2.254 \sqrt{1 + \frac{7.94 P_u}{f'_{co}}} - \frac{2 P_u}{f'_{co}} - 1.254$
3	Miyauchi <i>et al.</i> (1997)	$\frac{f'_{cc}}{f'_{co}} = 1 + 3.485 \left(\frac{P_u}{f'_{co}} \right)$
4	Samaan <i>et al.</i> (1998)	$\frac{f'_{cc}}{f'_{co}} = 1 + 0.6 P_u^{0.7}$
5	Lam and Teng (2001)	$\frac{f'_{cc}}{f'_{co}} = 1 + 2 \left(\frac{P_u}{f'_{co}} \right)$
6	Toutanji (1999)	$\frac{f'_{cc}}{f'_{co}} = 1 + 3.5 \left(\frac{P_u}{f'_{co}} \right)^{0.85}$
7	Saafi <i>et al.</i> (1999)	$\frac{f'_{cc}}{f'_{co}} = 1 + 2.2 \left(\frac{P_u}{f'_{co}} \right)^{0.84}$
8	Spoelstra and Monti (1999)	$\frac{f'_{cc}}{f'_{co}} = 0.2 + 3 \sqrt{\frac{P_u}{f'_{co}}}$
9	Karbhari and Gao (1997)	$\frac{f'_{cc}}{f'_{co}} = 1 + 2.1 \left(\frac{P_u}{f'_{co}} \right)^{0.87}$
10	Berthet <i>et al.</i> (2006)	$\frac{f'_{cc}}{f'_{co}} = 1 + K_1 \left(\frac{P_u}{f'_{co}} \right)$ $\begin{cases} K_1 = 3.45 & 20 \leq f'_{co} \leq 50 \text{ MPa} \\ K_1 = 0.95 (f'_{co})^{-1/4} & 50 \leq f'_{co} \leq 200 \text{ MPa} \end{cases}$

f'_{co} : Compressive strength of unconfined concrete cylinder;

f'_{cc} : Ultimate compressive strength of confined concrete cylinder;

P_u : Ultimate confinement pressure ($P_u = E_l \cdot \varepsilon_f = 2t \cdot f'_f / D$);

E_l : Lateral modulus; γ_f : Ultimate tensile strain of FRP laminate;

f'_f : Ultimate tensile strength of FRP layer; t : Thickness of FRP layer;

D : Diameter of concrete cylinder.

(Mirmiran *et al.* 2000). Considerable experimental research has been performed on the behavior of the CFRP-confined concrete columns (Miyachi *et al.* 1997, Matthys 1999, Shahawy *et al.* 2000, Rochette and Labossiere 2000, Micelli *et al.* 2001, Rousakis 2001). Numerous studies have concentrated on assessing the strength enhancement of CFRP-wrapped concrete cylinders in the literature. Some of the most important models in this field are shown in Table 1.

By extending developments in computational software and hardware, several alternative computer-aided data mining approaches have been developed. Pattern recognition systems, as an example, learn adaptively from experience and extract various discriminators. Artificial neural networks (ANNs) are the most widely used pattern recognition procedures. There has been some research with the specific objective of applying ANNs to the modeling of the strength enhancement of CFRP-confined concrete cylinders (Cevik and Guzelbey 2008). Despite the acceptable performance of ANNs, they usually do not give a definite function to calculate the outcome using the input values. The model equations obtained based on the fixed connection weights and bias factors of the ANN structures are often very complex and have long expressions. The ANN-based models are mostly appropriate to be used as a part of a computer program or via spreadsheet programming.

3. Genetic programming

GP is a symbolic optimization technique that creates computer programs to solve a problem using the principle of Darwinian natural selection. GP was introduced by Koza (1992) as an extension of the genetic algorithms (GAs). The programs evolved by GP are represented as tree structures and expressed in the functional programming language (Koza 1992). The main difference between the GA and GP approaches is that in GP the evolving programs (individuals) are parse trees rather than fixed-length binary strings. The traditional optimization techniques, like GA, are generally used in parameter optimization to evolve the best values for a given set of model parameters. GP, on the other hand, gives the basic structure of the approximation model together with the values of its parameters. In fact, GP optimizes a population of computer programs according to a fitness landscape determined by a program ability to perform a given computational task. The fitness of each program in the population is evaluated using a fitness function. Thus, the fitness function is the objective function GP aims to optimize (Torres 2009). GP is relatively a new field of pattern recognition methods in contrast with GA. A survey of the literature reveals the growing interest of the research community in GP.

In GP, a random population of individuals (trees) is created to achieve high diversity. The symbolic optimization algorithms present the potential solutions by structural ordering of several symbols. A population member in GP is a hierarchically structured tree comprising functions and terminals. The functions and terminals are selected from a set of functions and a set of terminals. For example, the function set F can contain the basic arithmetic operations (+, -, ×, /, etc.), Boolean logic functions (AND, OR, NOT, etc.), or any other mathematical functions. The terminal set T contains the arguments for the functions and can consist of numerical constants, logical constants, variables, etc. The functions and terminals are chosen at random and constructed together to form a computer model. The evolved model has a tree-like structure with a root point with branches extending from each function and ending in a terminal. An example of a simple tree representation of a GP model is illustrated in Fig. 3.

Creation of the initial population is a blind random search for solutions in the large space of

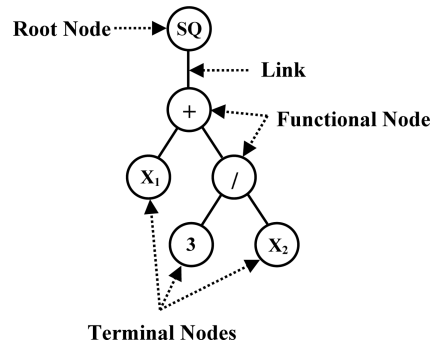
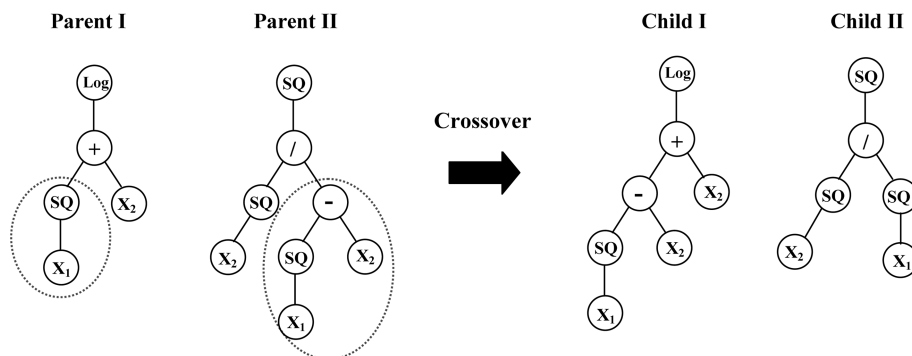
Fig. 3 The tree representation of a GP model $(X_1 + 3/X_2)^2$ 

Fig. 4 Typical crossover operation in GP

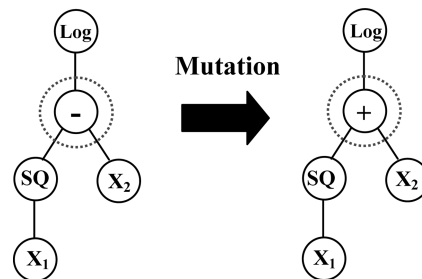


Fig. 5 Typical mutation operation in GP

possible solutions. Once a population of models is created at random, the GP algorithm evaluates the individuals, selects individuals for reproduction, generates new individuals by mutation, crossover, and direct reproduction, and finally creates the new generation in all iterations (Koza 1992). During the crossover procedure, a point on a branch of each solution (program) is selected at random and the set of terminals and/or functions from each program are then swapped to create two new programs as can be seen in Fig. 4. The evolutionary process continues by evaluating the fitness of the new population and starting a new round of reproduction and crossover. During this process, the GP algorithm occasionally selects a function or terminal from a model at random and mutates it (see Fig. 5). The best program that appeared in any generation, the best-so-far solution, defines the

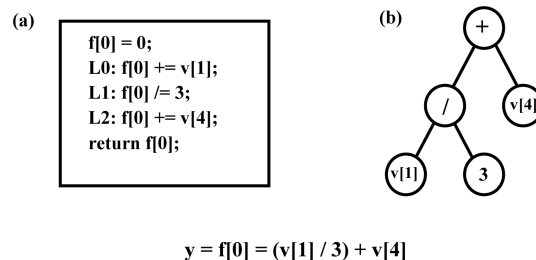


Fig. 6 Comparison of the GP program structures (a) LGP (b) tree-based GP (after Alavi *et al.* 2010c)

output of the GP algorithm (Koza 1992). In the following subsections, the coupled GP/SA and MEP algorithms are briefly described.

3.1 Hybrid genetic programming-simulated annealing algorithm

In this paper, GP with a SA-based selection strategy is employed for developing the prediction models. In this coupled algorithm, the SA strategy is used to select new individuals (Folino *et al.* 2000, Deschaine *et al.* 2000, Francone 2004). The GP system used in this study is linear genetic programming (LGP) (Brameier and Banzhaf 2001, 2007). LGP is a new subset of GP with a linear structure similar to the DNA molecule in biological genomes. The main characteristic of LGP in comparison with the traditional tree-based GP is that expressions of a functional programming language (like LISP) are substituted by programs of an imperative language (like C/C++) (Brameier and Banzhaf 2001). Fig. 6 presents a comparison of the program structures in LGP and tree-based GP. As shown in Fig. 6(a), a linear genetic program can be seen as a data flow graph generated by multiple usage of register content. That is, on the functional level the evolved imperative structure denotes a special directed graph. As can be observed from Fig. 6(b), in tree-based GP, the data flow is more rigidly determined by the tree structure of the program (Brameier and Banzhaf 2001). In the LGP system utilized here, an individual program is interpreted as a variable-length sequence of simple C instructions.

3.1.1 The SA algorithm

SA makes use of the Metropolis algorithm (Metropolis *et al.* 1953) for the computer simulation of annealing. Annealing is a process in which a metal is heated to a high temperature and then is gradually cooled to relieve thermal stresses. During the cooling process, each atom takes a specific position in the crystalline structure of the metal. By changing the temperature, this crystalline structure changes to a different configuration. An internal energy, E , can be measured and assigned to each state of crystalline structure of the metal which is achieved during the annealing process.

At each step of the cooling process, if the temperature does not decrease quickly the atoms are allowed to adjust to a stable equilibrium state of least energy. It is evident that changing of the crystalline structure of a metal, through the annealing, is associated with a changing of the internal energy as ΔE . However, as the metal temperature drops down gradually, the overall trend of changing internal energy follows a decreasing process but sometimes the energy may increase by chance. The probability of acceptance of an increase in internal energy by ΔE is given by Boltzmann's probability distribution function as follows

$$P(\Delta E) = e^{\frac{-\Delta E}{KT}} \quad (11)$$

where T is the temperature of the metal in Kelvin's temperature scale and K is the Boltzmann's constant. The crystalline structure of a metal achieves near global minimum energy states during the process of annealing. This process is simulated by SA to find the minimum of a function in a certain design space. The objective function corresponds to the energy state and moving to any new set of design variables corresponds to a change of the crystalline structural state.

3.1.2 The GP/SA algorithm

Considering the above explanations for GP and SA, the coupled GP/SA algorithm uses the following main steps to evolve a computer program (Deschaine *et al.* 2000, Francone 2004):

- I. A single program is initially created at random. This is the "parent" program for the first repetition of the learning cycle.
- II. The parent program is copied.
- III. A search operator, crossover or mutation, transforms the copy of the parent program. The transformed copy is called "child" program or "offspring" program. The crossover operator produces two children programs. But only one of these programs is compared with the parent as a candidate to replace the parent program.
- IV. The fitness value of the both parent and child program is calculated.
- V. Based on the fitness value of the child and parent program, the SA algorithm decides whether to replace the parent program with the child program. If the child has better fitness than the parent, the child always replaces its parent. If the child has worse fitness than the parent, the child replaces the parent probabilistically. The probability of replacement depends on how much worse the fitness of the child is than the parent and also on the SA temperature, T . As the annealing process continues, T is gradually reduced at each n th iteration. This means that, for the program, the probability of replacing a worse child to a better parent gets lower and lower as the run continues. If the child program replaces the parent program then the child program becomes the new parent for the next cycle. Alternatively, if the parent program is not replaced by the child, it remains as the parent program for the next cycle.
- VI. If the termination or convergence conditions are satisfied the process is terminated. Otherwise, the process is continued going step III.

A brief description of the basic parameters used by the GP/SA algorithm to direct a search for a program is given below (Francone 2004):

Temperature: Temperature in the GP/SA algorithm is just a number that controls the probability that a mutated child program will replace the parent program. Start and stop temperatures are values that a program uses for temperatures at the first and last temperature levels in a run.

Number of temperature levels: This parameter sets the number of temperature levels that the GP/SA algorithm will use before the program terminates the run. The proper number of temperature levels depends on the complexity of the problem.

Number of iterations per temperature: This parameter sets the number of times a new child program is created from the parent program at each temperature level.

Crossover rate: The crossover rate parameter in the GP/SA algorithm sets the balance between the uses of the search operators (crossover and mutation). A value of 50% means that 50% of time the used search operator will be the crossover operator. The mutation operator will therefore be

employed in the other 50% of time by the GP/SA algorithm.

Probability of randomly generated parent in crossover: This parameter selects the proportion of headless-chicken crossover versus the best program crossover. The headless-chicken crossover is very similar to crossover in GP. During this operation, the parent program is crossed over with a randomly created program that is the same length as the parent program. GP/SA uses only one child from each crossover operation whereas in GP, there are two.

Offspring choice rate: This parameter balances which of the child programs is chosen for comparison with the parent program.

Replacement scaling factor: This parameter is a scaling constant. As it decreases, the probability that a child will replace its parent decreases. This parameter may be used to force the algorithm to be pickier about letting worse fitness children replace better parents, particularly at the beginning of the run.

Fitness function: The fitness function is a criterion for the evaluation of the fittest computer program. It is used to determine which of the evolved programs survive and reproduce.

3.2 Multi expression programming

MEP is a subarea of GP developed by Oltean and Dumitrescu (2002). MEP uses linear chromosomes for solution encoding. It has a special ability to encode multiple solutions (computer programs) of a problem in a single chromosome. Based on the fitness values of the individuals, the best encoded solution is chosen to represent the chromosome. There are not increases in the complexity of the MEP decoding process compared with the other GP variants that store a single solution in a chromosome. The exception is on the situations where the set of training data is not known a priori (Oltean and Grosan 2003a). The evolutionary steady-state MEP algorithm starts by the creation of a random population of individuals. MEP uses the following steps to evolve the best expression along a specified number of generations until a termination condition is reached (Oltean and Dumitrescu 2002, Oltean and Grosan 2003b):

- i. Selecting two parents using a binary tournament procedure and recombining them with a fixed crossover probability.
- ii. Obtaining two offspring by the recombination of two parents.
- iii. Mutating the offspring and replacing the worst individual in the current population with the best of them (if the offspring is better than the worst individual in the current population).

MEP is represented similar to the way in which *C* and *Pascal* compilers translate mathematical expressions into machine code. The number of MEP genes per chromosome is constant and specifies the length of the chromosome. A terminal (an element in the terminal set T) or a function symbol (an element in the function set F) is encoded by each gene. A gene that encodes a function includes pointers towards the function arguments. The function parameters always have indices of lower values than the position of that function itself in the chromosome. The first symbol in a chromosome must be a terminal symbol as stated by the proposed representation scheme.

An example of a MEP chromosome can be seen below. Using the set of functions $F = \{+, \times, /\}$ and the set of terminals $T = \{x_1, x_2, x_3, x_4\}$, the example is given as follows:

- 0: x_1
- 1: x_2
- 2: \times , 0, 1
- 3: x_3

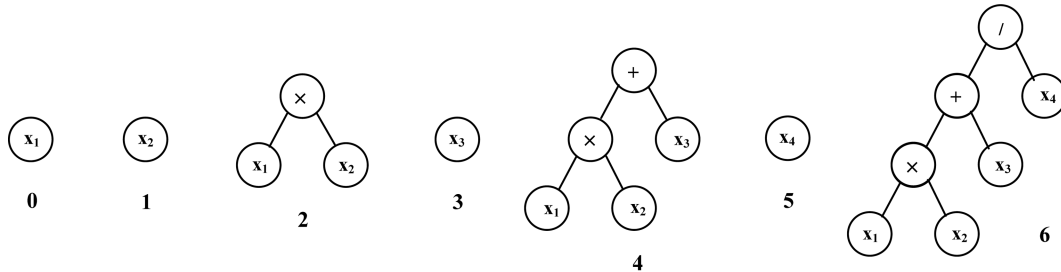


Fig. 7 Expressions encoded by an MEP chromosome represented as trees

4: + 2, 3

5: x_4

6: / 4, 5

Translation of the MEP individuals into computer programs can be obtained by reading the chromosome top-down starting with the first position. A terminal symbol defines a simple expression and each of function symbols specifies a complex expression obtained by connecting the operands specified by the argument positions with the current function symbol (Oltean and Dumitrescu 2002). In the present example, genes 0, 1, 3 and 5 encode simple expressions formed by a single terminal symbol. These expressions are: $E_0 = x_1$, $E_1 = x_2$, $E_3 = x_3$, $E_5 = x_4$. Gene 2 indicates the operation \times on the operands located at positions 0 and 1 of the chromosome. Therefore, gene 2 encodes the expression: $E_2 = x_1 \times x_2$. Gene 4 indicates the operation $+$ on the operands located at positions 2 and 3. Therefore, gene 4 encodes the expression: $E_4 = (x_1 \times x_2) + x_3$. Gene 6 indicates the operation $/$ on the operands located at positions 4 and 5. Therefore, gene 6 encodes the expression: $E_6 = ((x_1 \times x_2) + x_3)/x_4$. In order to choose one of these expressions (E_1, \dots, E_6) as the chromosome representer, multiple expressions in a single chromosome are encoded. Due to its multi expression representation, each MEP chromosome may be viewed as a forest of trees rather than a single tree (see Fig. 7). Each of these expressions can be considered as a possible solution of the problem. The fitness of each expression in an MEP chromosome is calculated to designate the best encoded expression in that chromosome. For solving symbolic regression problems, the fitness of an MEP chromosome may be computed using the following formula (Oltean and Grosan 2003a)

$$f = \min_{i=1,m} \left\{ \sum_{j=1}^n |E_j - O_j^i| \right\} \quad (12)$$

where n is the number of fitness cases; E_j is the expected value for the fitness case j ; O_j^i is the value returned for the j th fitness case by the i th expression encoded in the current chromosome, and m is the number of chromosome genes.

4. Development of compressive strength predictive models

The main objective of this paper is to formulate the compressive strength of CFRP-confined concrete cylinders (f'_{cc}) using the GP/SA and MEP approaches. Four different GP/SA and MEP

models (Model I, Model II, Model III and Model IV) were developed using two different combinations of the influencing variables. The first combination of the variables was used for the construction of Models I and III. The formulations of f'_{cc} (MPa) in these models were considered to be as follows

$$f'_{cc} = f(D, t, f'_f, f'_{co}) \tag{13}$$

where,

D (mm): Diameter of concrete cylinder

t (mm): Thickness of CFRP layer

f'_f (MPa): Ultimate tensile strength of CFRP laminate

f'_{co} (MPa): Unconfined ultimate concrete strength

It is well recognized that the ultimate compressive strength of FRP-confined concrete occurs at the hoop rupture of the confining FRP (Lorenzis and Tepfers 2003). The hoop rupture strain can be calculated from the ultimate tensile strength of the FRP laminate and its elastic modulus. Hence, the hoop rupture strain was implicitly taken into account by considering the ultimate tensile strength of the laminate as an input to Models I and III.

In order to conduct a fair comparison between the result of this study and the models found in the literature, the number of inputs to build Model II and Model IV was reduced to two parameters. The formulations of f'_{cc} in these models were considered to be as follows

$$f'_{cc} = f(P_u, f'_{co}) \tag{14}$$

in which, f'_{co} and P_u are respectively the unconfined ultimate concrete strength and ultimate confinement pressure in MPa. These parameters are the most widely used parameters in the existing FRP confinement models. As shown in Table 1, P_u is a function of D , t , and f'_f (Spoelstra and Monti 1999). Therefore, Models II and IV incorporate the effects of the parameters considered for developing Models I and III in implicit form.

Models I and II were developed using the GP/SA method, and Models III and IV were generated by the MEP technique. For the analysis, the available data sets were randomly divided into learning, validation and testing subsets. The learning data were taken for training (genetic evolution). The validation data were used to specify the generalization capability of the models on data they did not train on (model selection). Thus, both of the learning and validation data were involved in the modeling process and were categorized into one group referred to as “training data”. The models with the best performance on both of the learning and validation data sets were finally selected as the outcomes of the runs. The testing data were finally employed to measure the performance of the models obtained by GP/SA and MEP on the data that played no role in building the models. A trial study was conducted to find a consistent data division. The selection was such that the statistical properties (e.g., mean and standard deviation) of the training (learning and testing) and testing subsets were similar. To get the accurate result from the proposed models and to improve the learning speed, the input and output parameters were normalized between 0 and 1. After controlling several normalization methods (Swingler 1996), the following methods were selected for normalizing the data. The inputs and outputs of Models I and III were normalized as

$$X_n = \frac{X_i}{1.05X_{i,\max}} \quad (15)$$

where $X_{i,\max}$ is the maximum value of X_i , and X_n is the normalized value. To normalize f'_{co} , P_u , and f'_{cc} as the input and output parameters of Models II and IV, they were divided by 90, 40 and 140, respectively. The best GP/SA and MEP models were chosen on the basis of a multi-objective strategy as below:

- i. The simplicity of the models, although this was not a predominant factor.
- ii. Providing the best fitness value on the learning set of data.
- iii. Providing the best fitness value on a testing set of data.

In order to evaluate the performance of the proposed models, the correlation coefficient (R) and mean absolute percent error (MAPE) were used. R and MAPE are given in the form of formulas as follows

$$R = \frac{\sum_{i=1}^n (h_i - \bar{h}_i)(t_i - \bar{t}_i)}{\sqrt{\sum_{i=1}^n (h_i - \bar{h}_i)^2 \sum_{i=1}^n (t_i - \bar{t}_i)^2}} \quad (16)$$

$$MAPE = \frac{1}{n} \sum_{i=1}^n |h_i - t_i| \times 100 \quad (17)$$

where h_i and t_i are respectively the experimental and the calculated output value for the i th output, \bar{h}_i is the average of the experimental outputs, and n is the number of samples.

4.1 Experimental database

An experimental database of the strength enhancement of CFRP-wrapped concrete cylinders test results was obtained from the literature (Cevik and Guzelbey 2008) to develop the models. The database contains 101 specimens from seven separate studies. The database includes the measurements of D , t , f'_f , f'_{co} , P_u , and f'_{cc} . The first two variables are geometrical parameters (Fig. 8) and the others are mechanical properties. All the specimens used in the database have a length (L) to diameter (D) ratio of 2. Of the 101 data sets, 91 data vectors were taken for the training process (76 sets for learning and 15 sets for validation). The remaining 10 sets were used for the testing of the models. The GP/SA and MEP were developed using the same training and

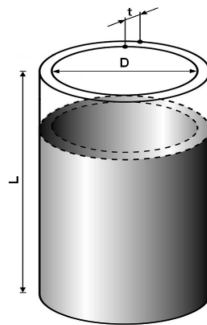


Fig. 8 Geometrical parameters of CFRP-wrapped concrete cylinder

Table 2 Descriptive statistics of the variables used in the model development

Parameter	Input					Output
	D (mm)	t (mm)	f'_f (MPa)	f'_{co} (MPa)	P_u (MPa)	f'_{co} (MPa)
Mean	134.43	0.48	2445.86	45.12	13.51	78.32
Standard Error	2.35	0.07	93.31	1.73	0.86	2.29
Median	150	0.34	2024	43	12.15	75.7
Standard Deviation	23.58	0.66	937.74	17.35	8.69	23.03
Sample Variance	555.83	0.43	879349.28	301	75.53	530.41
Kurtosis	-1.39	29.67	-0.41	-0.17	1.80	-0.57
Skewness	-0.80	5.06	0.09	0.78	1.48	0.39
Range	53	4.93	3590	62.73	34.93	104.1
Minimum	100	0.11	230	19.4	3.44	33.8
Maximum	153	5.04	3820	82.13	38.38	137.9
Sum	13577	48.56	247032	4556.68	1364.09	7910.07

Table 3 Parameter settings for the GP/SA algorithm

Parameter	Settings
Number of temperature levels	5000-7000
Number of iterations per temperature level	1000
Start temperature	5
Stop temperature	0.01
Crossover rate (%)	50, 95
Homologous crossover (%)	95
Probability of randomly generated parent in crossover (%)	99
Block mutation rate (%)	30
Instruction mutation rate (%)	30
Data mutation rate (%)	40
Offspring choice rate (%)	50
Replacement scaling factor	1
Maximum program size	256
Initial program size	80
Function set	+, -, ×, /, √, sin, cos, tan

testing data sets. Descriptive statistics of the variables used in the model development are given in Table 2.

4.2 Model construction using GP/SA

Various parameters are involved in the GP/SA predictive algorithm. The parameter selection will affect the model generalization capability of GP/SA. The parameter settings are shown in Table 3. In this study, four basic arithmetic operators (+, -, ×, /) and some basic mathematical functions (√,

sin, cos) were utilized to get the optimum GP/SA models. A large number of temperature levels were tested to find models with minimum error. The program was run until there was no longer significant improvement in the model performance or the runs terminated automatically. The number of iterations per temperature level was set to 1000. Values of 5 and 0.01 were considered for the start and stop temperatures, respectively. At the low level the crossover rate is 50% and at the high level it is 95%. The squared error function was used to calculate the overall fitness of the evolved programs. The values of the other involved parameters were selected based on some previously suggested values (Alavi *et al.* 2010b) and also after a trial and error approach. The GP/SA algorithm was implemented using the Discipulus Lite™ (Conrads *et al.* 2004) software.

4.2.1 Explicit formulation of compressive strength, Model I

The GP/SA-based formulation of the compressive strength (f'_{cc}), in terms of D , t , f'_f and f'_{co} , is as given below

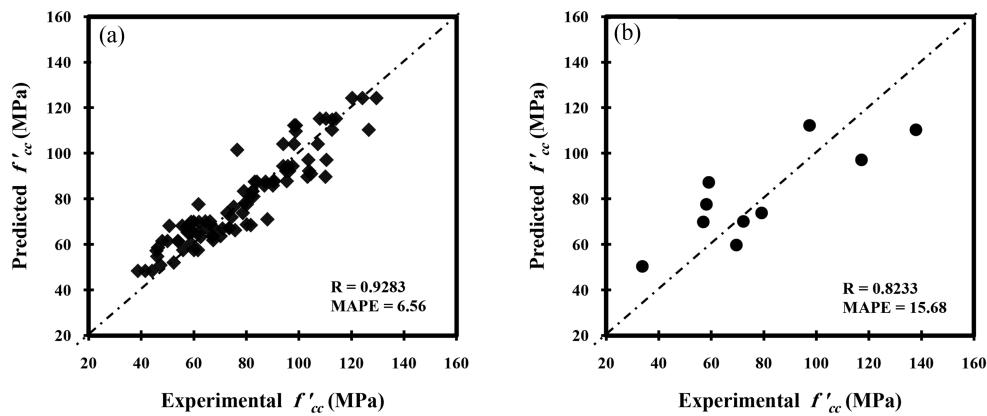


Fig. 9 Experimental versus predicted compressive strength using GP/SA, Model I (a) training data (b) testing data

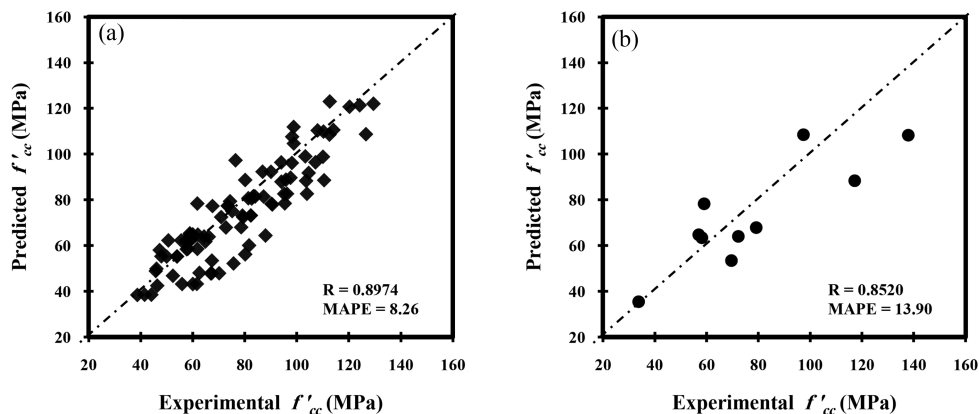


Fig. 10 Experimental versus predicted compressive strength using GP/SA, Model II (a) training data (b) testing data

$$f'_{cc,Mod.I}(\text{MPa}) = 2.4262 \sqrt{f'_{co} \sqrt{f'_f} t \cos\left(\cos\left(\frac{4011}{f'_f} \cos^2\left(\frac{20D}{3213}\right) + \frac{29f'_{co}}{2500}\right)\right)} \quad (18)$$

A comparison of the experimental and predicted compressive strength of CFRP-wrapped concrete cylinder by GP/SA, Model I is shown in Fig. 9. f'_{co} and P_u were considered in the formulation process of Model II. The compressive strength prediction equation for the best results by the GP/SA algorithm is as given below

$$f'_{cc,Mod.II}(\text{MPa}) = \frac{7f'_{co}(9P_u^2 + 1080P_u + 28800 - 160f'_{co})}{1620(P_u + 80)} \quad (19)$$

A comparison of the experimental and predicted compressive strength by Model II is shown in Fig. 10.

4.3 Model construction using MEP

Using two different sets of the predictor variables, two separate MEP prediction models (Model III and Model IV) were developed. Similar to Model I, Model III relates f'_{cc} to D , t , f'_f , and f'_{co} . Model IV correlates f'_{cc} with f'_{co} and P_u . As for GP/SA, the parameter selection will affect the model generalization capability of MEP. Various parameters involved in the MEP predictive algorithm are shown in Table 4. These parameters were selected based on some previously suggested values (Alavi and Gandomi 2010) and after a trial and error approach. Basic arithmetic operators and some basic mathematical functions were utilized to get the optimum MEP models. The proper number of population and generation often depends on the number of possible solutions. A fairly large number of population and generations were tested to find models with minimum error. The programs were run until the runs automatically terminated. The mutation rate was set to 10%. The crossover rates were 50% and 95% at the low and high levels, respectively. The number of expressions encoded by each MEP chromosome is equal to the chromosome length. This parameter directly influences the size of the search space and the number of solutions explored within the search space. The success of the MEP algorithm usually increases with increasing the chromosome length. In this case, the complexity of the evolved function increases and the speed of the algorithm decreases (Oltean 2006). An optimal value equal to 50 genes was selected for the chromosome length as a tradeoff between the running time and the complexity of the evolved

Table 4 Parameter settings for the MEP algorithm

Parameter	Settings
Population size	500-1000
Chromosome length	50 genes
Number of generations	250
Crossover probability	0.5,0.9
Crossover type	Uniform
Mutation probability	0.01
Terminal set	Problem inputs
Function set	+, -, ×, /, exp, sin, cos

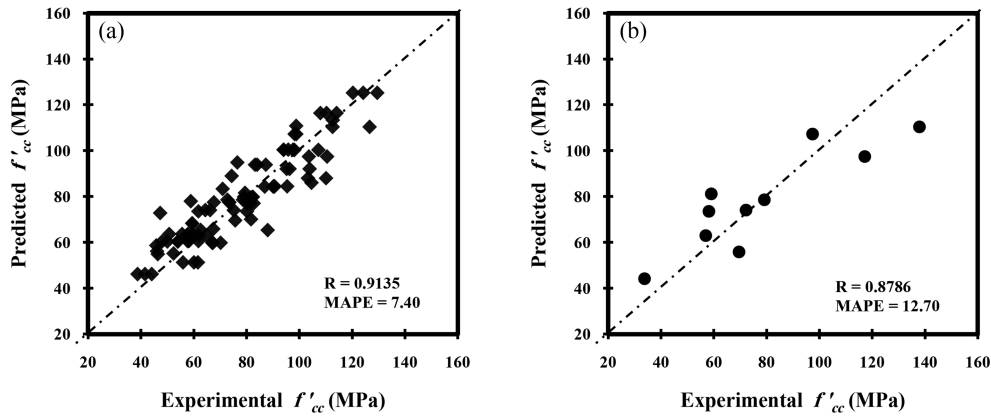


Fig. 11 Experimental versus predicted compressive strength using MEP, Model III (a) training data (b) testing data

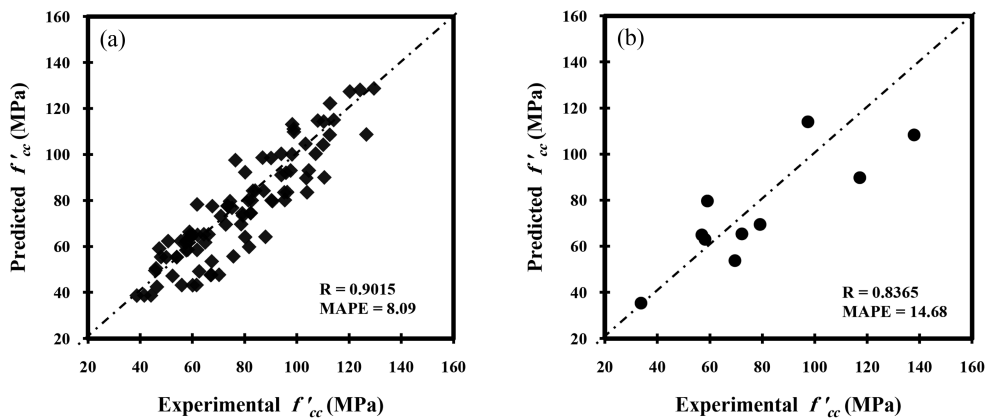


Fig. 12 Experimental versus predicted compressive strength using MEP, Model IV (a) training data (b) testing data

solutions. For the analysis, source code of MEP (Oltean 2004) in C++ was modified by the authors to be utilizable for the available problem.

4.3.1 Explicit formulation of compressive strength, Model III

The MEP-based formulation of f'_{cc} , in terms of D , t , f'_f , and f'_{co} is as given below

$$f'_{cc,Mod.III}(\text{MPa}) = 1.2235f'_ff'_{co}D\left(\cos\left(\sin\left(\frac{14D}{425t}\right)\right) - \frac{29f'_{co}}{1250} + \frac{1000t}{1323}\right) \times 10^{-6} + \frac{925tf'_f}{72198} + \frac{1971f'_{co}}{1250} \quad (20)$$

A comparison of the experimental and predicted compressive strength of CFRP-wrapped concrete cylinder by MEP, Model III is shown in Fig. 11. The f'_{cc} prediction equation in terms of f'_{co} and P_u is as given below

$$f'_{cc,Mod.IV}(\text{MPa}) = \left(140e^{\frac{P_u}{40} - \frac{f'_{co}}{90}} - 7P_u + \frac{28f'_{co}}{9}\right) \left(e^{\frac{P_u}{40}} - 40e^{\frac{P_u}{40} - \frac{f'_{co}}{90}}\right) + \frac{14f'_{co}}{9} \left(\frac{P_u}{40} - \frac{f'_{co}}{90}\right) \quad (21)$$

A comparison of the experimental and predicted compressive strength of CFRP-wrapped concrete cylinder by Model IV is shown in Fig. 12.

5. Performance analysis and model validity

Four prediction equations were obtained for the compressive strength of confined concrete cylinder by means of the GP/SA and MEP methods. Fig. 13 visualizes the compressive strength predictions made by different models for the entire database. Based on a logical hypothesis (Smith 1986), if a model gives a correlation coefficient (R) > 0.8 , and the error (e.g., MAPE) values are at

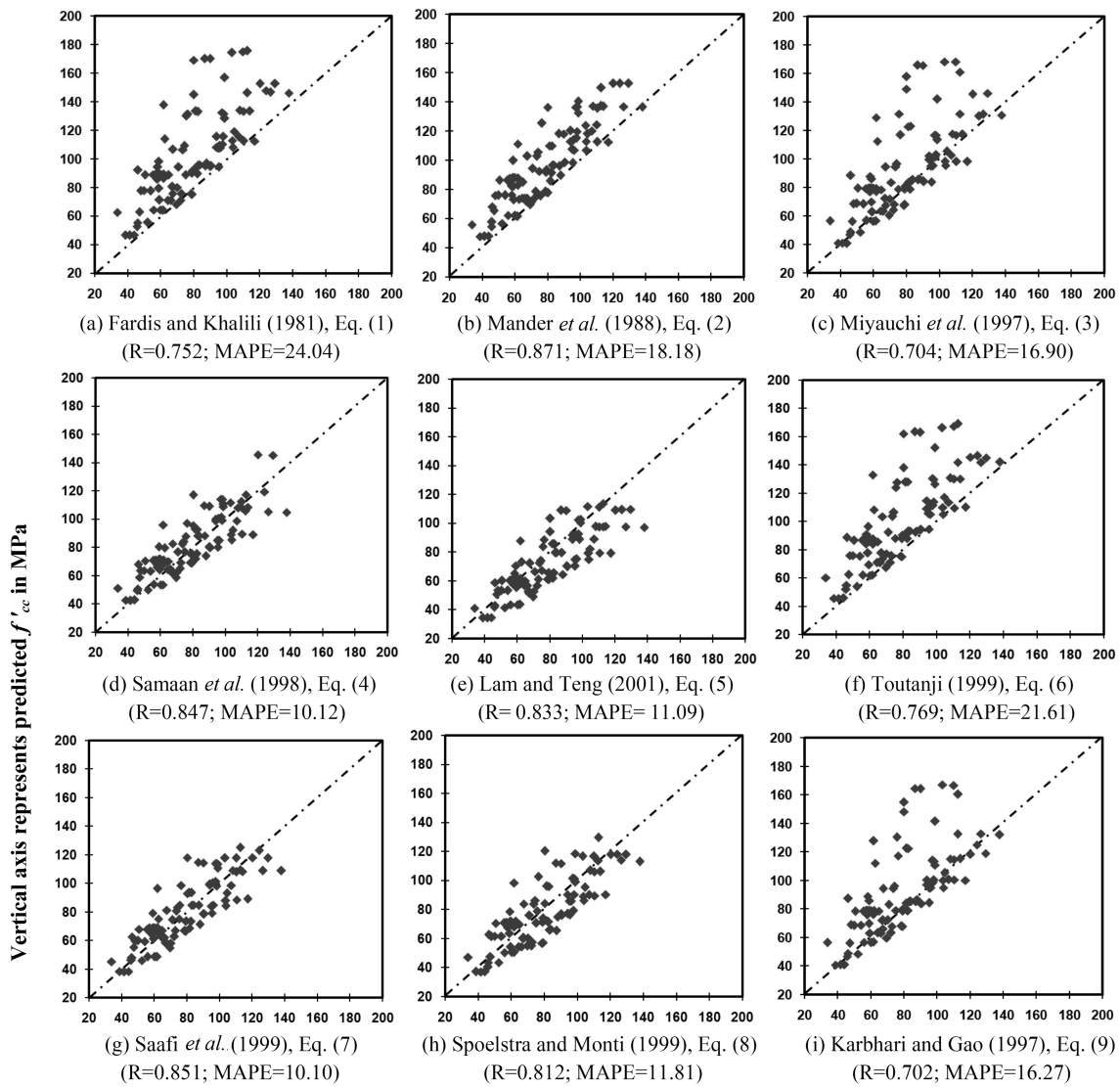
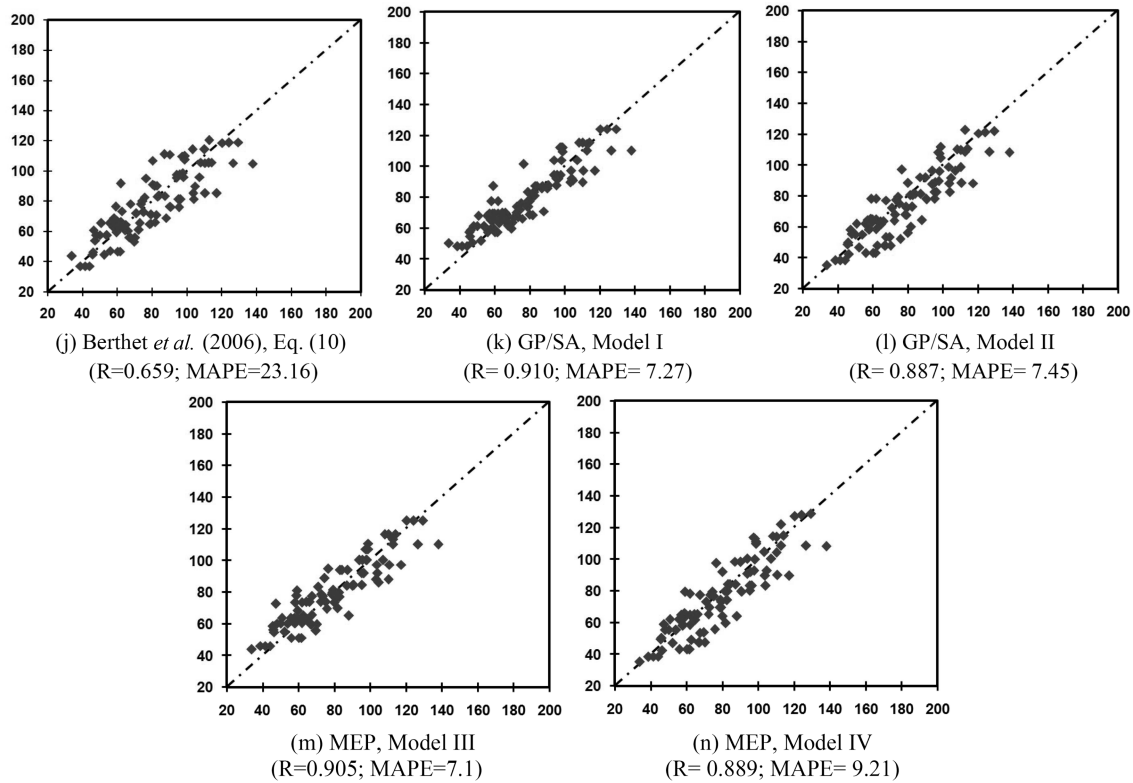


Fig. 13 Comparisons of the experimental versus predicted f'_{cc} values using different models



Horizontal axis represents experimental f'_{cc} in MPa

Fig. 13 Continued

the minimum, there is a strong correlation between the predicted and measured values. The model can therefore be judged as very good. It can be observed from Figs. 9-13 that the GP/SA and MEP models with high R and low MAPE values predict the target values with a high degree of accuracy. The GP/SA, Model I has provided the best performance on the training (R = 0.9283, MAPE = 6.56) and whole of data (R = 0.910, MAPE = 7.27). On the testing data, MEP (Model III) with R and MAPE values respectively equal to 0.8786 and 12.70 outperforms the other models. Overall performance of the models demonstrates that the models developed using the first combination of the input parameters (D , t , f'_f , f'_{co}) have provided better results than those developed using the second combination (f'_{co} , P_u).

It is known that the models derived using the ANNs, GP/SA, MEP or other soft computing tools, in most cases, have a predictive capability within the data range used for their development. This is because of the nature of these techniques and distinguishes them from the other conventional techniques. The amount of data used for the modeling process is an important issue, as it bears heavily on the reliability of the final models. To cope with this limitation, Frank and Todeschini (1994) argue that the minimum ratio of the number of objects over the number of selected variables for model acceptability is 3. They also suggest that considering a ratio equal to 5 is safer. In the present study, this ratio is much higher and is equal to $101/4 = 25.25$. Furthermore, new criteria recommended by Golbraikh and Tropsha (2002) were checked for the external validation of the GP/

Table 5 Statistical parameters of the GP/SA and MEP models for the external validation

Item	Formula	Condition	GP/SA Model I	GP/SA Model I	MEP Model III	MEP Model IV
1	R	$R > 0.8$	0.823	0.852	0.879	0.837
2	$k = \frac{\sum_{i=1}^n (h_i \times t_i)}{h_i^2}$	$0.85 < K < 1.15$	0.982	1.074	1.013	1.054
3	$k' = \frac{\sum_{i=1}^n (h_i \times t_i)}{t_i^2}$	$0.85 < K' < 1.15$	0.973	0.898	0.955	0.913
4	$m = \frac{R^2 - Ro^2}{R^2}$	$m < 0.1$	-0.472	-0.317	-0.294	-0.396
5	$n = \frac{R^2 - Ro'^2}{R^2}$	$n < 0.1$	-0.456	-0.206	-0.254	-0.305
where	$Ro^2 = 1 - \frac{\sum_{i=1}^n (t_i - h_i^o)^2}{\sum_{i=1}^n (t_i - \bar{t}_i)^2}$, $h_i^o = k \times t_i$		0.998	0.956	0.999	0.977
	$Ro'^2 = 1 - \frac{\sum_{i=1}^n (h_i - t_i^o)^2}{\sum_{i=1}^n (h_i - \bar{h}_i)^2}$, $t_i^o = k' \times h_i$		0.987	0.875	0.968	0.913

h_i : Actual output value for the i th output; t_i : Predicted output value for the i th output; \bar{h}_i : Average of actual outputs; \bar{t}_i : Average of predicted outputs; n : Number of sample.

SA and MEP models on the testing data sets. It is suggested that at least one slope of regression lines (k or k') through the origin should be close to 1. Also, the performance indexes of m and n should be lower than 0.1. Either the squared correlation coefficient (through the origin) between predicted and experimental values (Ro^2), or the coefficient between experimental and predicted values (Ro'^2) should be close to 1. The validation criteria and the relevant results obtained by the models are presented in Table 5. Models are considered valid, if they satisfy the required conditions. This verification phase ensures that the derived models are strongly valid, have prediction power and are not chance correlations.

It can also be observed from Fig. 13 that the GP/SA and MEP-based models considerably outperform the models found in the literature. Most of the available models have been derived through the conventional regression analyses. The regression analysis can have large uncertainties. It has major drawbacks for idealization of complex processes, approximation, and averaging widely varying prototype conditions. Another important issue is due to the limitation of this method. The regression analysis tries to model the nature of the corresponding problem by a pre-defined linear or nonlinear equation, which is not always true. In most cases, the best models developed using the commonly used statistical approaches are obtained after controlling just some equations established in advance. Thus, they cannot efficiently consider the interactions between the dependent and independent variables. On the other hand, GP/SA and MEP have significant abilities to model the

Table 6 GP/SA and MEP models for strength enhancement of CFRP-confined concrete cylinders

Model	Expression
GP/SA, Model I	$\frac{f'_{cc}}{f'_{co}} = 2.4262 \sqrt{\frac{f'_f t}{f'_{co}}} \cos\left(\cos\left(\frac{4011}{f'_f} \cos^2\left(\frac{20D}{3213}\right) + \frac{29f'_{co}}{2500}\right)\right)$
GP/SA, Model II	$\frac{f'_{cc}}{f'_{co}} = \frac{63P_u^2 + 7560P_u + 201600 - 1120f'_{co}}{1620(P_u + 80)}$
MEP, Model III	$\frac{f'_{cc}}{f'_{co}} = 1.2235f'_f D \left(\cos\left(\sin\left(\frac{14D}{425t}\right)\right) - \frac{29f'_{co}}{1250} + \frac{1000t}{1323} \right) \times 10^{-6} + \frac{925tf'_f}{72198f'_{co}} + \frac{1971}{1250}$
MEP, Model IV	$\frac{f'_{cc}}{f'_{co}} = \left(\frac{140}{f'_{co}} e^{\frac{P_u - f'_{co}}{40 - 90}} - \frac{7P_u}{f'_{co}} + \frac{28}{9} \right) \left(e^{\frac{P_u}{40}} - e^{\frac{P_u - f'_{co}}{40 - 90}} \right) + \frac{14}{9} \left(\frac{P_u}{40} - \frac{f'_{co}}{90} \right)$

mechanical behavior without any prior assumptions. The best solutions (equations) evolved by this technique are determined after controlling numerous preliminary models, even millions of linear and nonlinear models. In addition to their acceptable performance, the GP/SA and MEP prediction equations are relatively simple and can be expressed similar to the form of other existing models (see Table 6). As more data become available, including those for other types of FRP, the same models can be improved to make more accurate predictions for a wider range.

Note that one of the goals of introducing expert systems, such as the GP-based approaches, into the design processes is better handling of the information in the pre-design phase. The initial steps of design are based on imprecise and incomplete information about the features and properties of targeted output or process (Kraslawski *et al.* 1999). Nevertheless, it is idealistic to have some initial estimates of the outcome before performing any extensive laboratory or field work. The GP/SA and MEP approaches employed in this research are based on the data alone to determine the structure and parameters of the model. Thus, the derived models are considered to be mostly valid for use in preliminary design stages and should cautiously be used for final decision-making. For more reliability, the results of the GP/SA and MEP-based analyses are suggested to be compared with those obtained using deterministic methods.

In order to develop more sophisticated prediction tools, the models obtained using GP/SA and MEP can be combined with advanced deterministic models. Assuming the deterministic model captures the key physical mechanisms, it needs appropriate initial conditions and carefully calibrated parameters to make accurate predictions. An idea could be to calibrate the parameters by the use of GP/SA and MEP which take into account the historic data sets as well as the laboratory test results. This allows integrating the uncertainties related to testing conditions which the conventional constitutive models do not explicitly account for. Also, GP/SA and MEP provide a structured representation for the constitutive material model that can readily be incorporated into the finite element or finite difference analyses. In this case, it is possible to use a suitably trained GP/SA or MEP-based model instead of a conventional (analytical) constitutive model in a numerical analysis tool such as finite element code.

6. Sensitivity and parametric analyses

Sensitivity analysis is of utmost concern for selecting the important predictor variables. The contributions of the predictor variables were evaluated through a sensitivity analysis. For this aim, frequency values of the variables were obtained. A frequency value equal to 1.00 for an input indicates that this variable has been appeared in 100% of the best thirty programs evolved by GP/SA and MEP. This is a common methodology for the sensitivity analysis in the GP-based studies (Francone 2001, Alavi *et al.* 2010a). The frequency values of the input parameters of the models are presented in Fig. 14. The results for the models type I and III indicate that the compressive strength of CFRP-wrapped concrete cylinder is more dependent on f'_f and f'_{co} than on D and t (Fig. 14(a)). As shown in Fig. 14(b), the compressive strength is more sensitive to f'_{co} than P_u in the models of type II and IV. There are earlier findings for the compressive strength that are in agreement with this observation (Gandomi *et al.* 2010a).

For further verification of the models, a parametric study was performed in this study. The main

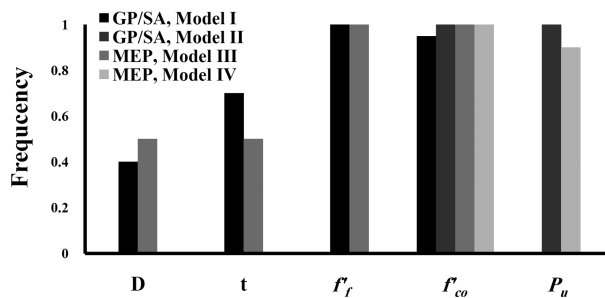


Fig. 14 Contributions of the predictor variables in the GP/SA and MEP models

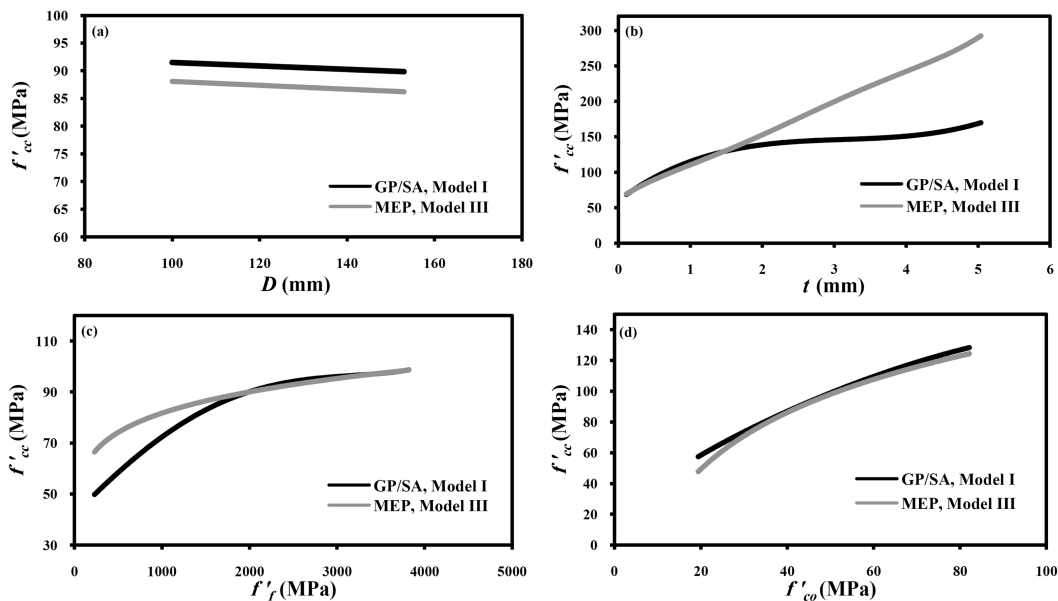


Fig. 15 Parametric analysis of f'_{cc} in the GP/SA and MEP models (Models I and III)

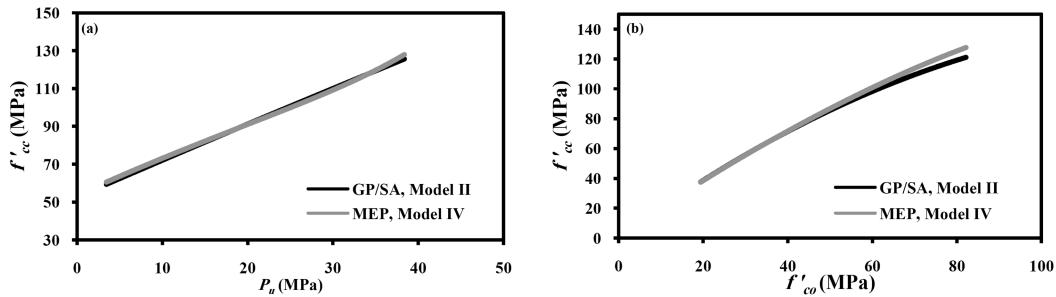


Fig. 16 Parametric analysis of f'_{cc} in the GP/SA and MEP models (Model II and IV)

goal is to find the effect of each parameter on the compressive strength of CFRP-wrapped concrete cylinders. Figs. 15 and 16 present the predicted values of the compressive strength as a function of each parameter for Models I, II, III, and IV. The tendency of the prediction to the geometrical parameters (t , D) and mechanical properties (f'_f , f'_{co} , P_u) can be determined according to these figures.

Fig. 14 presents the results of the parametric study for GP/SA, Model I, and MEP, Model III. The results indicate that f'_{cc} continuously increases due to increasing t , f'_f , and f'_{co} and slightly decreases due to increasing D . It is well known that, by inhibiting lateral expansion of concrete, its strength and ductility improve significantly (Mirmiran *et al.* 2000, Rousakis *et al.* 2008). According to Poisson's effect, for a given value of axial compression stress, applied on FRP confined concrete cylinders, the lateral expansion changes depend on the elastic modulus and therefore on the tensile strength of FRP materials. For this reason, there is a direct relationship between the compressive strength of CFRP confined concrete cylinders and the tensile strength of CFRP materials. Considering the results of the parametric analysis for Models II and IV, as shown in Fig. 16, it can be seen that f'_{cc} continuously increases due to increasing f'_{co} and P_u . The results of the parametric analysis for the proposed models are expected cases from a civil engineering viewpoint. The results are also in close agreement with those reported by other researchers (e.g., Spoelstra and Monti 1999, Xiao and Wu 2000, Berthet *et al.* 2006).

7. Conclusions

New equations were obtained for predicting the compressive strength of CFRP-confined concrete columns using the GP/SA and MEP methodologies. A reliable database of previously published ultimate strength of concrete cylinders test results was used for developing the models. The proposed models are capable of predicting the ultimate strength of concrete cylinders after CFRP confinement with high accuracy. Overall, the GP/SA and MEP models using the same predictor variables reach a similar prediction performance. The validity of the models was tested for a part of test results beyond the training data domain. New criteria were also checked for the external validation of the prediction models. The validation phases confirm the effectiveness and robustness of the models for their further application to the compressive strength estimation. Better performance of the models developed using D , t , f'_f and f'_{co} implies the necessity of using these four parameters for the analyses rather than f'_{co} and P_u . The derived models were benchmarked

against several CFRP confinement models in the literature and found to be more accurate. The sensitivity and parametric analyses were performed and supported by the experimental evidence and the results presented by other researchers. The developed models can reliably be used for routine pre-planning and pre-design purposes in that they were derived from tests on samples with a wide range of properties. The models derived using GP/SA and MEP are basically different from the conventional constitutive models based on the first principles (e.g., elasticity and plasticity theories). One of the distinctive features of GP/SA and MEP-based constitutive models is that they are based on the experimental data rather than on the assumptions made in developing the conventional models. As more data becomes available, these models can be improved by re-training GP/SA and MEP. The major advantage of employing the GP/SA and MEP-based models is that the compressive strength can accurately be estimated without carrying out destructive, sophisticated and time-consuming laboratory tests.

References

- Alavi, A.H., Ameri, M., Gandomi, A.H. and Mirzahosseini, M.R. (2010b), "Formulation of flow number of asphalt mixes using a hybrid computational method", *Constr. Build. Mater.*, DOI: 10.1016/j.conbuildmat.2010.09.010. (in press)
- Alavi, A.H., Gandomi, A.H. and Heshmati, A.A.R. (2010c), "Discussion on soft computing approach for real-time estimation of missing wave heights", *Ocean Eng.*, DOI: 10.1016/j.oceaneng.2010.06.003. (in press)
- Alavi, A.H., Gandomi, A.H., Sahab, M.G. and Gandomi, M. (2010a), "Multi expression programming: a new approach to formulation of soil classification", *Eng. Comp.*, **26**(2), 111-118.
- Alavi, A.H. and Gandomi, A.H. (2010), "A robust data mining approach for formulation of geotechnical engineering systems", *Int. J. Comput. Aided Meth. Eng.-Eng. Computations*. (in press)
- Baykasoglu, A., Gullub, H., Canakci, H. and Ozbakir, L. (2008), "Prediction of compressive and tensile strength of limestone via genetic programming", *Expert. Syst. Appl.*, **35**(1-2), 111-123.
- Berthet, J.F., Ferrier, E. and Hamelin, P. (2006), "Compressive behavior of concrete externally confined by composite jackets, Part B: modeling", *Const. Build. Mater.*, **20**(5), 338-347.
- Brameier, M. and Banzhaf, W. (2001), "A comparison of linear genetic programming and neural networks in medical data mining", *IEEE T. Evolut. Comput.*, **5**(1), 17-26.
- Brameier, M. and Banzhaf, W. (2007), *Linear Genetic Programming*, Springer Science + Business Media, New York.
- Canakci, H., Baykasoglu, A. and Güllü, H. (2009), "Prediction of compressive and tensile strength of Gaziantep basalts via neural networks and gene expression programming", *Neural Comput. Appl.*, **18**(8), 1031-1041.
- Cerny, V. (1985), "Thermodynamical approach to the traveling salesman problem: an efficient simulation algorithm", *J. Optimiz. Theory App.*, **45**, 41-52.
- Cevik, A. and Sonebi, M. (2008), "Modelling the performance of self-compacting SIFCON of cement slurries using genetic programming technique", *Comput. Concr.*, **5**(5), 475-490.
- Cevik, A. and Guzelbey, I.H. (2008), "Neural network modeling of strength enhancement for CFRP-confined concrete cylinders", *Build. Environ.*, **43**(5), 751-763.
- Conrads, M., Dolezal, O., Francone, F.D. and Nordin, P. (2004), *Discipulus Lite™-fast Genetic Programming based on AIM Learning Technology*, Register Machine Learning Technologies Inc., Littleton.
- Deschaine, L.M., Zafran, F.A., Patel, J.J., Amick, D., Pettit, R., Francone, F.D., Nordin, P., Dilkes, E. and Fausett, L.V. (2000), "Solving the unsolved using machine learning, data mining and knowledge discovery to model a complex production process", *Proceedings of the Advanced Technology Simulation Conference*, Washington DC, April.
- Fardis, M.N. and Khalili, H. (1981), "Concrete encased in fiberglass-reinforced plastic", *J. Am. Concr. Ins.*, **78**(6), 440-446.
- Fardis, M.N. and Khalili, H. (1982), "FRP-encased concrete as a structural material", *Mag. Concr. Res.*, **34**(121),

- 191-202.
- Folino, G., Pizzuti, C. and Spezzano, G. (2000), "Genetic programming and simulated annealing: A hybrid method to evolve decision trees", *Proceedings of the EuroGP'2000*, 1802, 294-303.
- Francone, F.D. (2001), *Discipulus Pro™ Software Owner's Manual*, Littleton, CO, USA, Machine Learning Technologies Inc.
- Francone, F.D. (2004), *Discipulus Lite™ Software Owner's Manual*, Littleton, CO, USA, Machine Learning Technologies Inc.
- Frank, I.E. and Todeschini, R. (1994), *The Data Analysis Handbook*, Amsterdam, Elsevier, The Netherland.
- Gandomi, A.H., Alavi, A.H. and Sahab, M.G. (2010a), "New formulation for compressive strength of CFRP confined concrete cylinders using linear genetic programming", *Mater. Struct.*, **43**(7), 963-983.
- Gandomi, A.H., Alavi, A.H., Mirzahosseini, M.R. and Moghadas Nejad, F. (2010b), "Nonlinear genetic-based models for prediction of flow number of asphalt mixtures", *J. Mater. Civil Eng. ASCE*, DOI: 10.1061/(ASCE)MT.1943-5533.0000154. (in press)
- Golbraikh, A. and Tropsha, A. (2002), "Beware of q^2 ", *J. Mole. Graph. Model.*, **20**, 269-276.
- Karhari, V.M. and Gao, Y. (1997), "Composite jacketed concrete under uniaxial compression verification of simple design equation", *J. Mater. Civil Eng.-ASCE*, **9**(4), 185-193.
- Kirkpatrick, S., Gelatt, C.D. and Vecchi, M.P. (1983), "Optimisation by simulated annealing", *Science*, **220**(4598), 671-680.
- Koza, J.R. (1992), *Genetic Programming: On the Programming of Computers by Means of Natural Selection*, MIT Press, Cambridge (MA).
- Kraslawski, A., Pedrycz, W. and Nyström, L. (1999), "Fuzzy neural network as instance generator for case-based reasoning system: an example of selection of heat exchange equipment in mixing", *Neural Comput. Appl.*, **8**(2), 106-113.
- Lam, L. and Teng, J.G. (2001), "Strength models for circular concrete columns confined by FRP composites", *Proceedings of the Fiber Reinforced Plastics for Reinforced Concrete Structures*, London.
- Lorenzis, L. (2001), "A comparative study of models on confinement of concrete cylinders with FRP composites", PhD thesis, Chalmers University of Technology.
- Lorenzis, L. and Tepfers, R. (2003), "Comparative study of models on confinement of concrete cylinders with fiber-reinforced polymer composites", *J. Comp. Constr.*, **7**(3), 219-237.
- Mander, J.B., Priestley, M.J.N. and Park, R. (1988), "Theoretical stress-strain model for confined concrete", *J. Struct. Eng.*, **114**(8), 1804-1849.
- Matthys, S., Taerwe, L. and Audenaert, K. (1999), "Tests on axially loaded concrete columns confined by fiber reinforced polymer sheet wrapping," *Proceedings of the 4th International Symposium Fiber Reinforced Polymer Reinforcement for Reinforced Concrete Structures (FRPRCS-4)*, 217-228.
- Metropolis, N., Rosenbluth, A.W., Rosenbluth, M.N., Teller, A.H. and Teller, E. (1953), "Equation of state calculations by fast computing mechanics", *J. Chem. Phys.*, **21**(6), 1087-1092.
- Micelli, F., Myers, J.J. and Murthy, S. (2001), "Effect of environmental cycles on concrete cylinders confined with FRP", *Proceedings of the International Conference on Composites in Construction (CCC 2001)*, Porto, Portugal, October.
- Mirmiran, A., Zagers, K. and Yuan, W. (2000), "Nonlinear finite element modeling of concrete confined by fiber composites", *Finite. Elem. Anal. Des.*, **35**, 79-96.
- Miyauchi, K., Nishibayashi, S. and Inoue, S. (1997), "Estimation of strengthening effects with carbon fiber sheet for concrete column", *Proceedings of the 3rd International Symposium (FRPRCS-3) on Non-metallic (FRP) Reinforcement for Concrete Structures*, Sapporo, Japan.
- Mousavi, S.M., Gandomi, A.H., Alavi, A.H. and Vesalimahmood, M. (2010), "Modeling of compressive strength of HPC mixes using a combined algorithm of genetic programming and orthogonal least squares", *Struct. Eng. Mech.*, **36**(2), 225-241.
- Oltean, M. (2004), *Multi Expression Programming Source Code*. Available at: <http://www.mep.cs.ubbcluj.ro/>
- Oltean, M. (2006), *Multi Expression Programming*, Technical Report, Babeş-Bolyai University, Cluj-Napoca, Romania.
- Oltean, M. And Dumitrescu, D. (2002), *Multi Expression programming*. Technical report, UBB-01-2002, Babeş-Bolyai University, Cluj-Napoca, Romania.

- Oltean, M. and Grosan, C. (2003a), "A comparison of several linear genetic programming techniques", *Adv. Complex Syst.*, **14**(4), 1-29.
- Oltean, M. and Grosan, C. (2003b), "Evolving evolutionary algorithms using multi expression programming", *Proceedings of the 7th European Conference on Artificial Life*, Dortmund. LNAI, Springer-Verlag.
- Richart, F.E., Brandtzaeg, A. and Brown, R.L. (1928), "A study of the failure of concrete under combined compressive stresses", University of Illinois, Engineering Experimental Station, Urbana, IL, Bulletin No. 185.
- Rochette, P. and Labossiere, P. (2000), "Axial testing of rectangular column models confined with composites", *J. Comp. Constr.*, **4**(3), 129-136.
- Rousakis, T. (2001), "Experimental investigation of concrete cylinders confined by carbon frp sheets, under monotonic and cyclic axial compressive load", Research Report, Goteborg, Sweden, Chalmers University of Technology.
- Rousakis, T.C., Karabinis, A.I., Kiouisis, P.D. and Tepfers, R. (2008), "Analytical modelling of plastic behaviour of uniformly FRP confined concrete members", *Compos.: Part B*, **39**(7-8), 1104-1113.
- Saafi, M., Toutanji, H.A. and Li, Z. (1999), "Behavior of concrete columns confined with fiber reinforced polymer tubes", *ACI Mater. J.*, **96**(4), 500-509.
- Samaan, M., Mirmiran, A. and Shahawy, M. (1998), "Model of concrete confined by fiber composites", *J. Struct. Eng.*, **124**(9), 1025-1031.
- Shahawy, M., Mirmiran, A. and Beitelmann, T. (2000), "Tests and modeling of carbon-wrapped concrete columns", *Compos. Part B: Eng.*, **31**(6-7), 471-480.
- Smith, G.N. (1986), *Probability and Statistics in Civil Engineering*, Collins, London.
- Spoelstra, M.R. and Monti, G. (1999), "FRP-confined concrete model", *J. Comp. Constr.*, **3**(3), 143-150.
- Swingler, K. (1996), *Applying Neural Networks a Practical Guide*, Academic Press, New York.
- Torres, R.S., Falcao, A.X., Goncalves, M.A., Papa, J.P., Zhang, B., Fan, W. and Fox, E.A. (2009), "A genetic programming framework for content-based image retrieval", *Pattern Recogn.*, **42**(2), 283-292.
- Toutanji, H. (1999), "Stress-strain characteristics of concrete columns externally confined with advanced fiber composite sheets", *ACI Mater. J.*, **96**(3), 397-404.
- Xiao, Y. and Wu, H. (2000), "Compressive behavior of concrete confined by carbon fiber composite jackets", *J. Mater. Civil Eng.*, **12**(2), 139-146.